

CCT TUNABLE LED STRIPS

120 LEDs/m



Features

- Powered by high output 2835 LED.
- 99.99% gold thread, pure copper bracket coated with silver.
- CRI 80/90/95 available.
- SDCM ≤ 3, 1 BIN only.
- Double layer rolled copper FPC.
- 3M 300LSE tape attached.
- CE, RoHS, UL, TUV, BIS, CB and LM-80 certified.

Application

- Linear lighting, city lighting, landscape lighting, commercial lighting and house contour lighting, etc.



Parameters

Part Number	Dimensions (mm)	LED Type	LED Qty/m	Voltage (V)	Power (W/M)	LM/M	CCT/K	IP Grade
SE120LA1-10-DW	5000*10	2835	120	DC12	12	1200	2700/6500	IP20
SE120LC1-10-DW	5000*10	2835	120	DC24	12	1200	2700/6500	IP20

Dimension

Unit: mm

120 LEDs/m DC12V

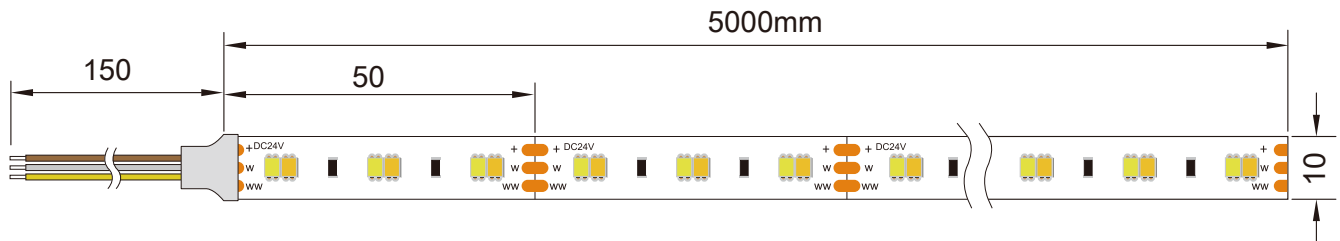

120 LEDs/m DC24V

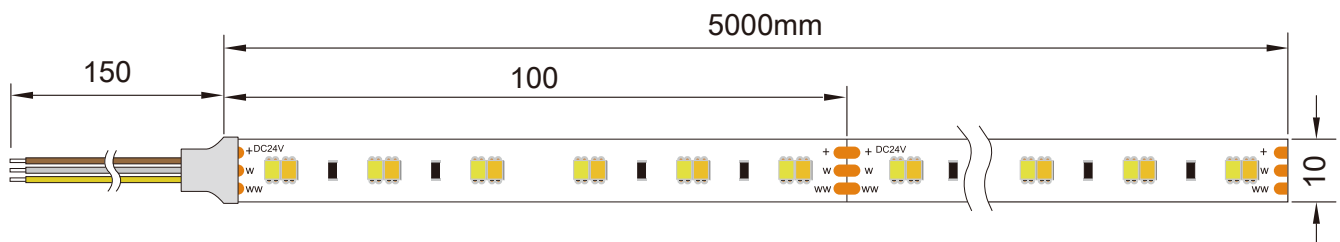

Rendering Index Comparison

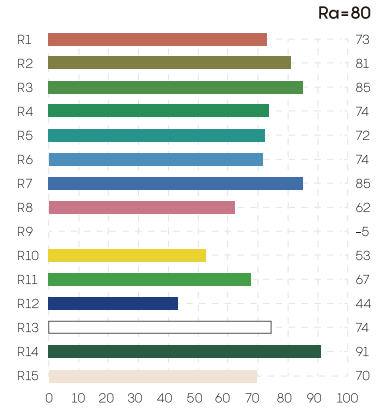
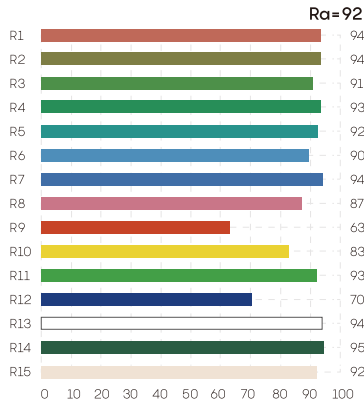

LBY LED Provides Different IP Graded Strips

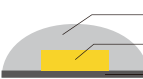
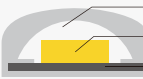
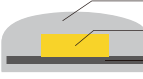
IP20	non-proof		LED FPC	(indoor)
IP65	glue coating		Silicon glue LED FPC	(in humid air)
IP67	silicon pipe		Silicon glue LED FPC	(in rain)
IP68	silicon		Silicon glue LED FPC	(in water)

LBY LED Provide Full CCT Range From 2700K to 6500K

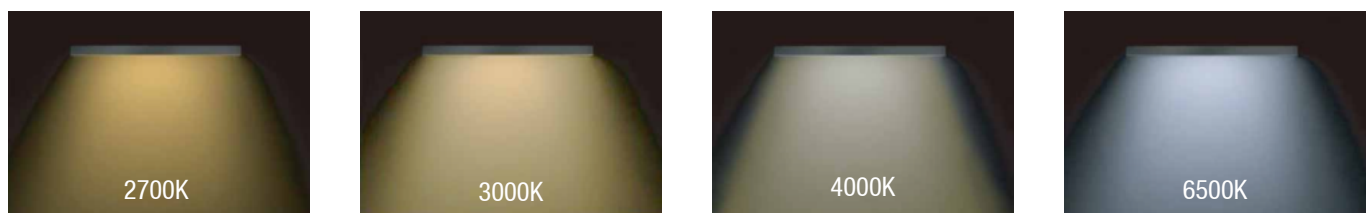

Beaming Angle

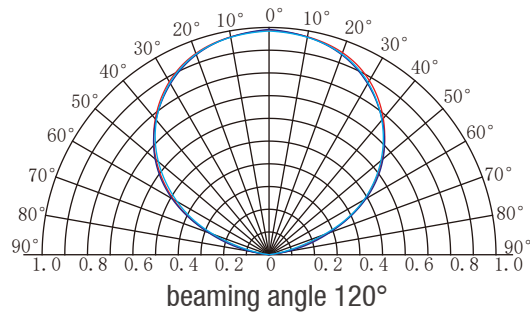

Wire Connection

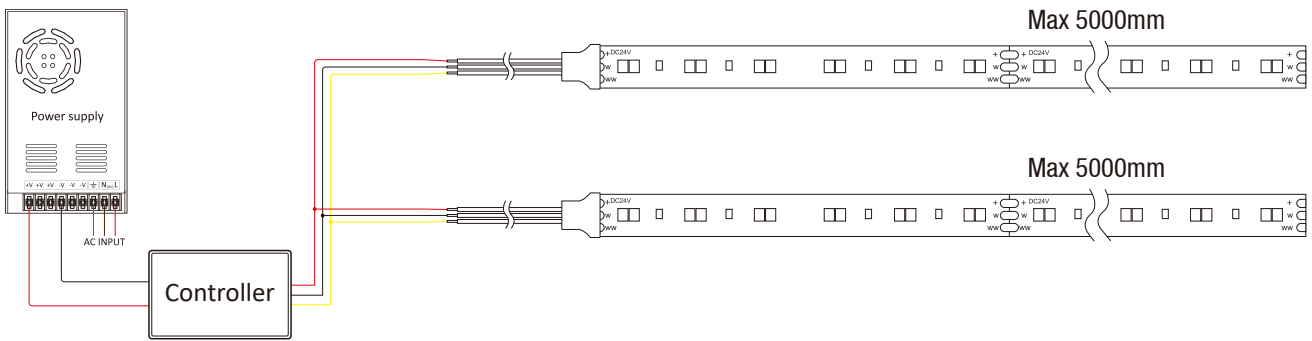

Packing information

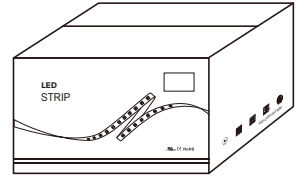
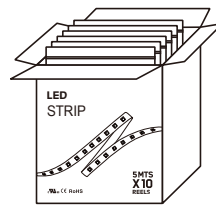
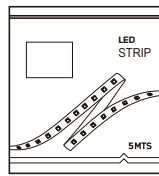
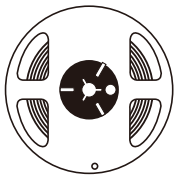

5 meters per roll

One roll per antistatic bag

10 rolls per inner box

450m per carton IP33

Part Number	Carton Dimension (mm)	Bags Per Carton (pcs)	Quantity Per Carton (m)	Net Weight (kg)	Gross Weight (kg)
SE120LA1-10-DW	495*450*215	90	450	5.0	7.5

Given the packing manner difference, the actual packing information is subject to that for the real products.

Cautions

When install the led strip, please note the installaiton technique. The led strip can be bent, but not distorted, as shown below.

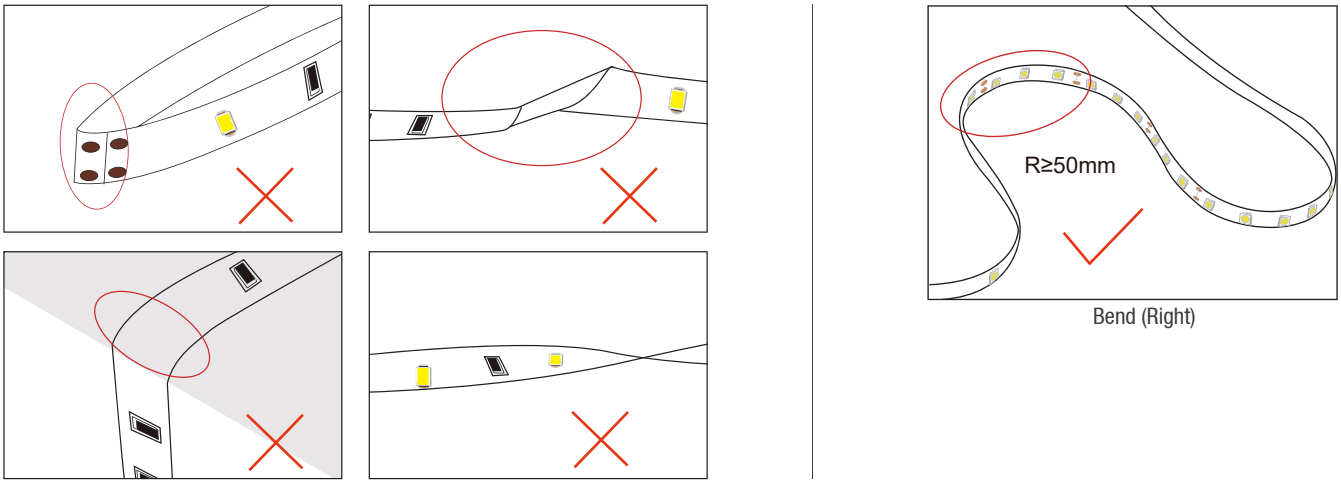

➤ LED strips are low vottage products, you must use the power supply(transformer). Please don't connect the led strip directly to the AC 110V or AC 220V, otherwise it will burn out the LED strips.

➤ Clean up the installation surface, it will ensure the reliability of the adhesive, .The electrical connection process must be operated by a professional person.

Installation Guidance

Accessories	Item No.	Description
Solderless Connector	LBY-JXD20-D1/D2/T1/T2	Insert the wire and close the cover
Strip-to-Wire Connector	LBY-N12XB-2G/QJ-SE-N12XB-2G	Insert the wire and strip and ensure secure contact
Strip-to-Strip Connector	LBY-N12BB-2G/QJ-SE-N12BB-2G	Insert both strips and ensure secure contact



- Clean the installation surface.
- Mounting with 3M tape.
 - (1) Unroll the led strip.
 - (2) Peel the adhesive tape.
 - (3) Stick the led strip into place.



- Mounting with clip.
 - (1) Unroll the led strip.
 - (2) Mount with fixing clip and secure with M3*6 screws.

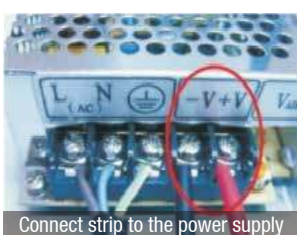

- Connect to the power supply and proceed with insulation treatment. Make sure that the polarity for connection is correct. Note: Red wire is positive and black wire is negative.
- Electrify the power supply.

Instructions

01. Disassembling or modifying the product is not allowed.
02. Installation with power on is not allowed.
03. Any organic solvent chemical is not allowed.
04. Isolation and corrosion prevention on all wiring points and wire ends.
05. Make sure the power wire is big enough and ensure the voltage and connection are all correct before power on.
06. Installation, maintenance should be done by professional staff.
07. 5M in a serial connection maximum for DC 12/24V strips.
08. The power wire between power supply and LED strips should be less than two meters to keep the same brightness on all parts.

Declaration

01. Warranty: 3 years.
02. To ensure the safety, the broken wires need to be replaced by the manufacturer or the service agent, or by the qualified staff.
03. The given data in the specification is the laboratory data, there may be discrepancy found in the actual products.
04. The given drawings in the specification are only for reference, there may be discrepancy found in the actual products.
05. The products are subject to change without prior notification.



SHENZHEN LINGBENYANG IND. CO., LTD.

Tel: +86-755-83544570

E-mail: info@lbyled.com

Fax: +86-755-83056229

[Http://: www.lbyled.com](http://www.lbyled.com)

Company Address.: 28F, Luban Building, Hongli West Road, Futian District, Shenzhen 518034, China

Factory Address: 6F, Xinyongfeng Industrial Area, Yingrenshi Village, Shiyan Town, Bao'an District, Shenzhen 518108, China